

<b>KBP4</b>		
	玻璃钝化整流桥 GLASS PASSIVATED BRIDGE RECTIFIERS	版本号 201603-A

### 主要参数 MAIN CHARACTERISTICS

$I_{F(AV)}$	2	A
$V_{RRM}$	50-1000	V
$I_{FSM}$	100	A
$I_R$	5	$\mu A$
$V_{FM}$	1.1	V



### 产品特性 FEATURES

- 范围到1000V
- 印刷电路板的理想器件
- 可信赖的低消耗建设造型塑料技术
- 塑料包装已保险商实验室可燃性分类94V-0
  
- Rating to 1000V PRV
- Ideal for printed circuit board
- Reliable low cost construction utilizing molded plastic technique
- The plastic material has UL flammability classification 94V-0

### 应用领域 APPLICATIONS

General purpose use in AC/DC bridge full wave rectification for power supply, home appliances, office equipment, industrial automation applications.

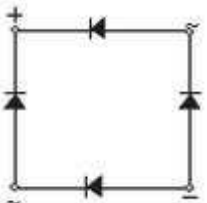
在AC/DC桥式全波整流一般用途，电源，家电，办公设备，工业自动化应用。

<p>符号 Symbol</p> 	<p>封装 Package</p>  <p style="text-align: center;"><b>KBP</b></p>
--	--

## 最大范围和电性参数

## MAXIMUM RATINGS AND ELECTRICAL CHARACTERISTICS

在25℃环境温度额定值除非另有规定。

Ratings at 25℃ ambient temperature unless otherwise specified.

单相，半波，60赫兹，有阻碍的或诱导的负载。

Single phase, half wave, 60Hz, resistive or inductive load.

为电容性负载，减免电流20%。

For capacitive load, derate current by 20%.

特性 CHARACTERISTIC	SYMBOL	KBP 4005	KBP 401	KBP 402	KBP 404	KBP 406	KBP 408	KBP 410	UNIT
最大反向重复峰值电压 Maximum Repetitive Peak Reverse Voltage	$V_{RRM}$	50	100	200	400	600	800	1000	V
最大均方根输入电压 Maximum RMS Voltage	$V_{RMS}$	35	70	140	280	420	560	700	V
最大直流阻塞电压 Maximum DC Blocking Voltage	$V_{DC}$	50	100	200	400	600	800	1000	V
最大正向平均整流电流 Maximum Average Forward Rectified Current	$I_{(AV)}$	4.0							A
正向浪涌峰值电流 Peak Forward Surge Current 8.3ms single half sine-wave superimposed on rated load	$I_{FSM}$	100							A
最大正向电压 Maximum forward Voltage at 17.5A DC	$V_F$	1.1							V
(额定)最大直流反向漏电流 Maximum DC Reverse Current at Rated DC Blocking Voltage @ $T_J=25^\circ\text{C}$ @ $T_J=125^\circ\text{C}$	$I_R$	5.0 500							$\mu\text{A}$
正向浪涌电流的平方对电流 $I^2t$ Rating for fusing( $t<8.3\text{ms}$ ),(Note 1)	$I^2t$	41.5							$\text{A}^2\text{S}$
典型结电容 Typical Junction Capacitance per element (Note 3, see Fig.1)	$C_J$	35							pF
典型热电阻 Typical Thermal Resistance (Note 3, see Fig.1)	$R_{\theta JC}$	6.0							$^\circ\text{C}/\text{W}$
操作结温范围 Operating Temperature Range	$T_J$	-55 to +150							$^\circ\text{C}$
存储温度范围 Storage Temperature Range	$T_{STG}$	-55 to +150							$^\circ\text{C}$

注意事项：1.测得非重复，对T超过1ms的少于超过8.3ms的。

2.测得1.0MHz和应用4.0伏特的反向电压。

3.器件装在300mm\*300mm\*1.6mm的铜金属散热板上。

NOTES: 1.Measured at no-repetitive, for greater than 1ms and less than 8.3ms

2.Measured at 1.0MHz and applied reverse voltage of 4.0V DC.

3.Device mounted on 300mm \*300mm\*1.6mm Cu Plate Heatsink.

## 机械参数 MECHANICAL DATA

案例：模压塑料带散热器整体安装在桥梁封装

极性：如本体图示

Case:Molded plastic with Heatsink internally mounted in the bridge encapsulation

Polarity:As marked on Body

## 特征曲线 ELECTRICAL CHARACTERISTICS (curves)



图1. 正向电流随温度变化曲线



图2. 最大非重复浪涌电流随周期变化曲线

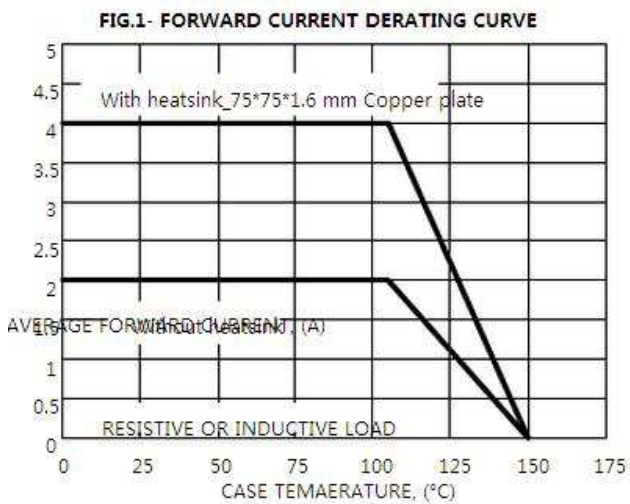

图3. 结电容随反向电压变化曲线

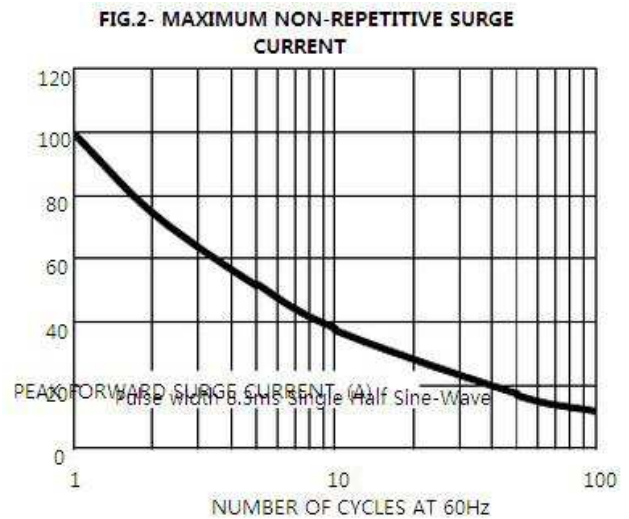

图4. 电性正向特性曲线

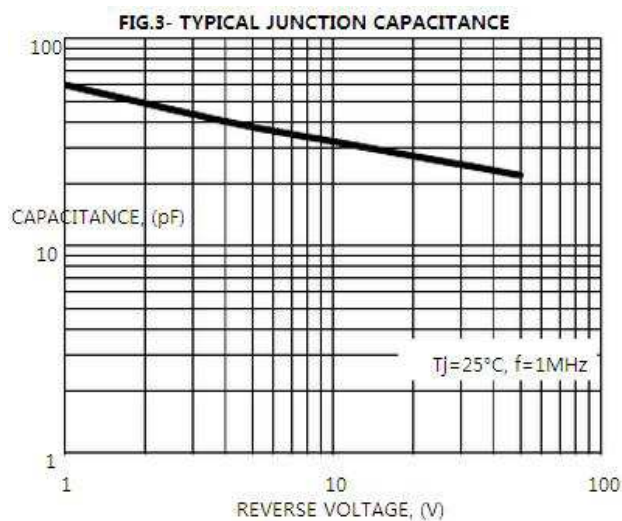

图5. 典型反向特性曲线

## 封装尺寸 TPACKAGE MECHANICAL DATA

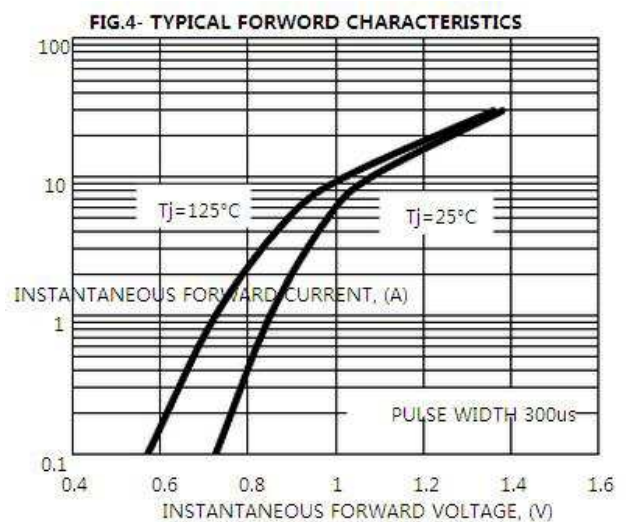

## 修改履历 Revision History

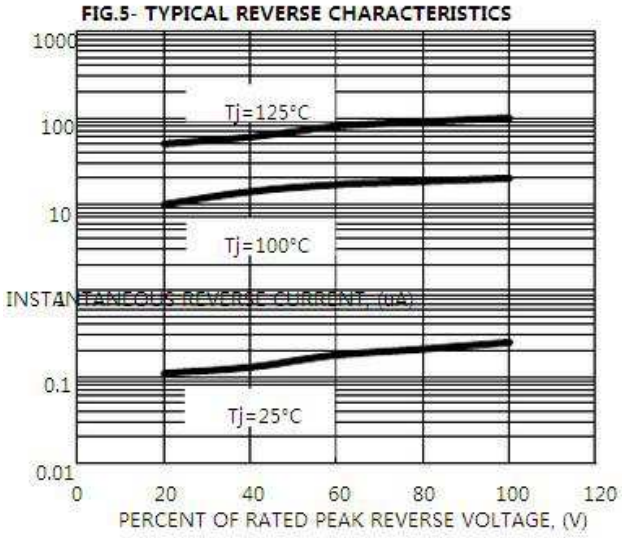
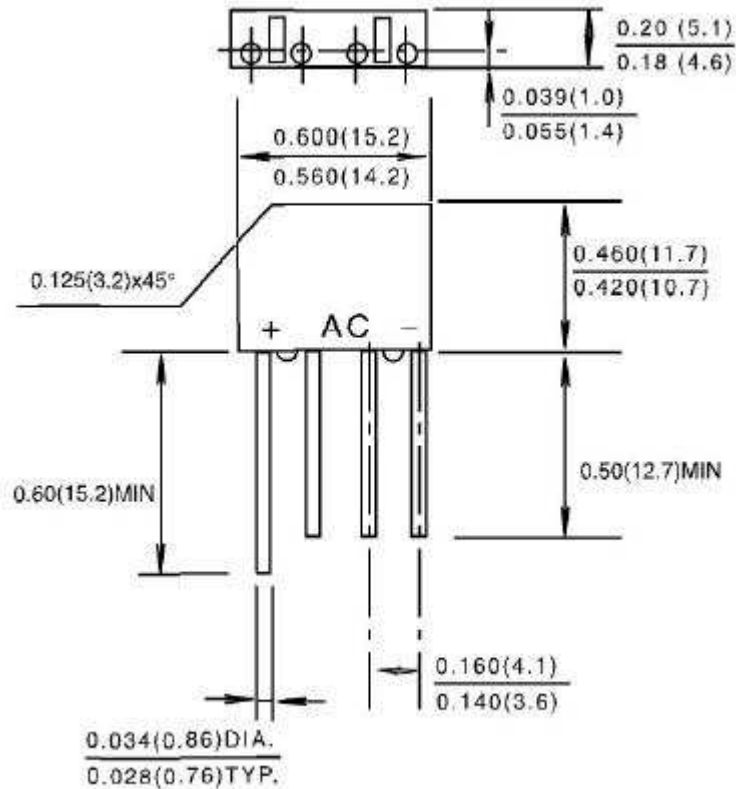
修改时间 Date	修改内容Content modification	旧版本Last Rev.	新版本New Rev.

## 注意事项 Note

- 1、 在应用中，如果超出最大额定值使用势必会导致器件损伤，甚至造成永久失效，这将影响到整机系统的可靠性。建议在器件的80%最大额定值范围内使用。
- 2、 在安装散热片的时候，请注意扭矩及散热片的平整度。
- 3、 本说明书如有版本变更不另行通知。

1. Exceeding the maximum ratings of the device in performance may cause damage to the device , even the permanent failure, which may affect the dependability of the machine. It is suggested to be used under 80 percent of the maximum ratings of the device.
2. When installing the heatsink , please pay attention to the torsional moment and the smoothness of the heatsink.
3. This publication is made by Dongguang Microelectronics and subject to regular change without notice.